

Article number: 204490ZD382SR
 Description: E+G Ball catches
 GN 4490-ZD-38-2-SR

Measures

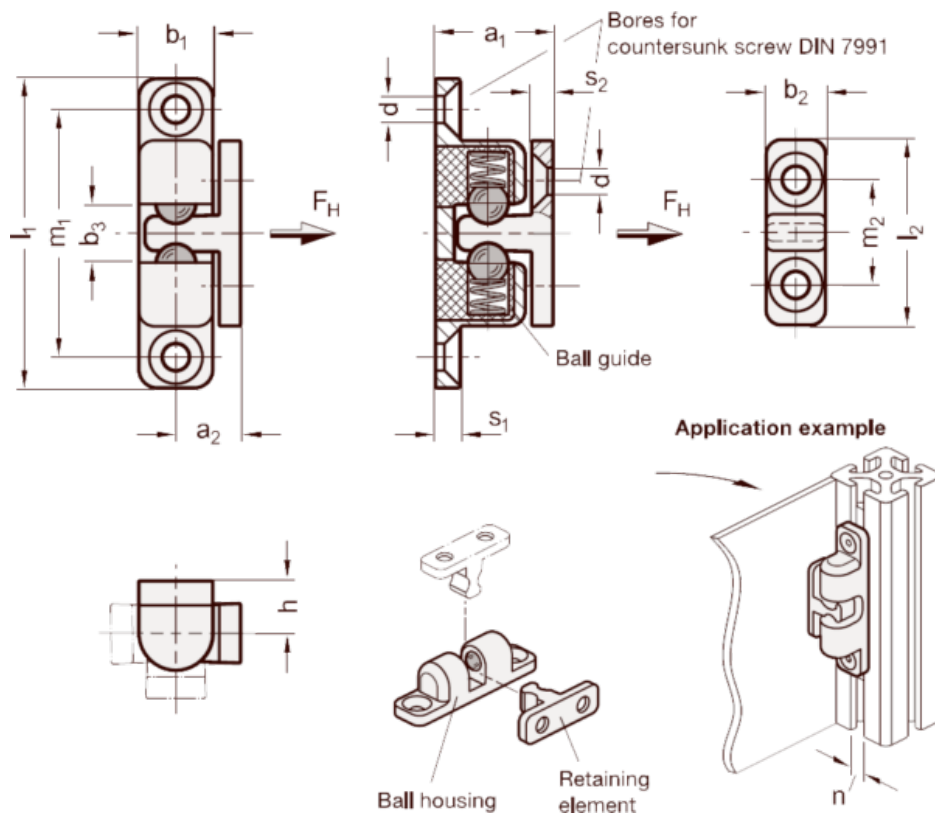

a1	= 15	Holding force FH in N	= 35
a2	= 7.5	l1	= 38
b1	= 8	l2	= 21
b2	= 7	m1	= 30
b3	= 4.3	m2	= 12
d	= M 3	s1	= 4
for nut width n	= ? 4.5	s2	= 2.5
h	= 7.5	Weight in (g)	= 12